

6-5 Transversals & Parallel Lines (ver2)_hw

Find the measure of each angle indicated.

1)

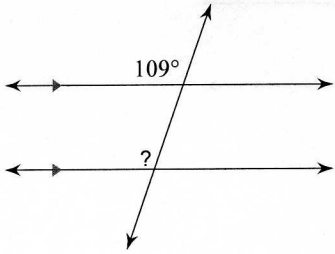

2)

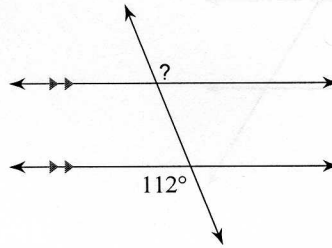

3)

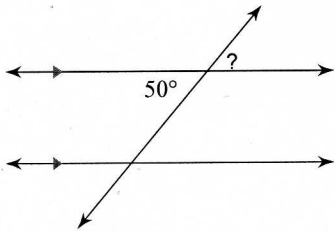

4)

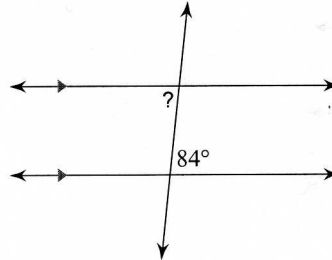

5)

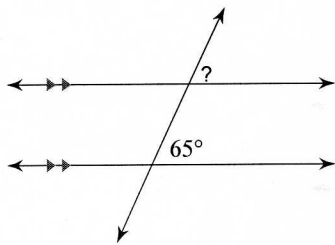

6)

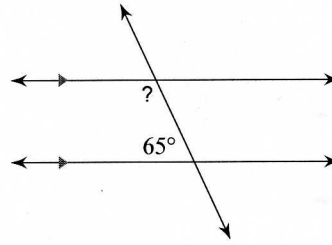

7)

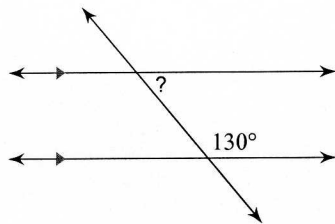

8)

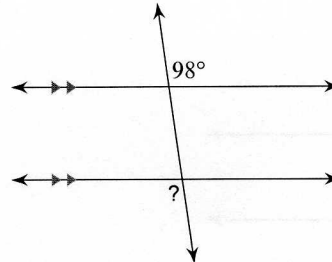

9)

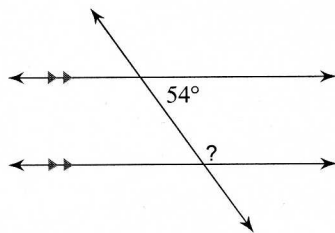

10)

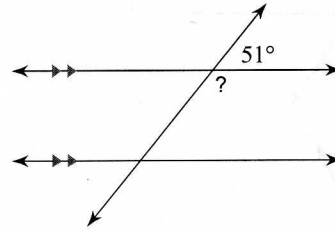

11)

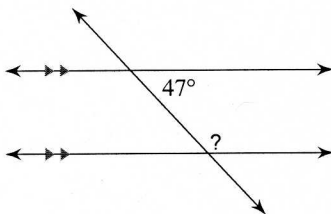

12)

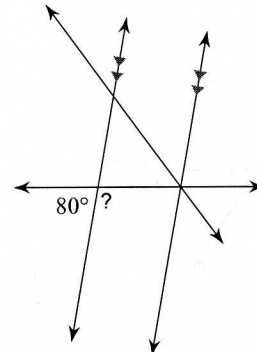

13)

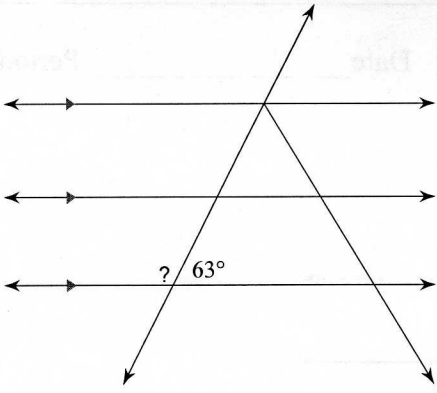

14)

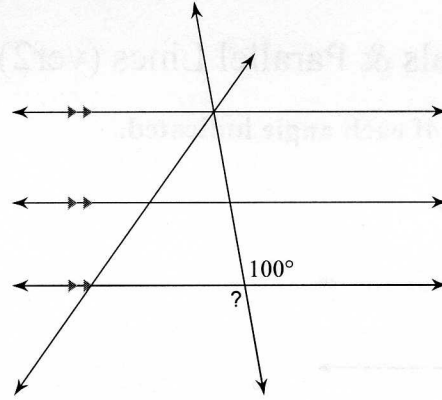

15)

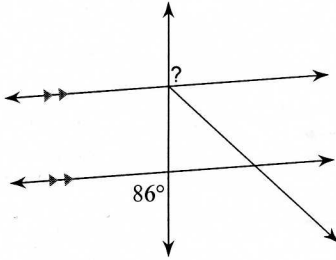

16)

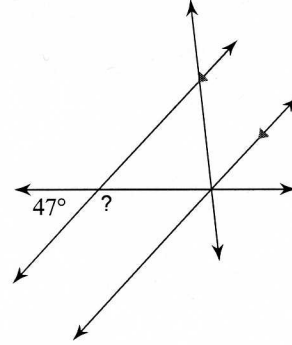

17)

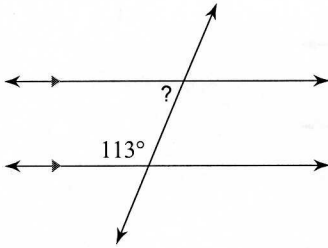

18)

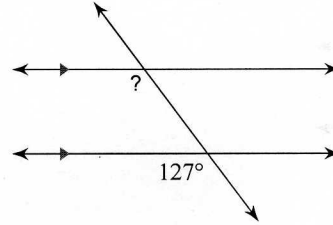

19)

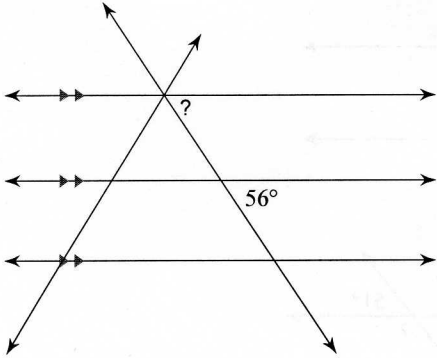

20)

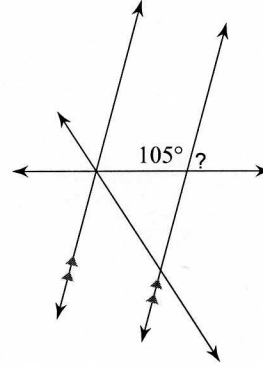

21)

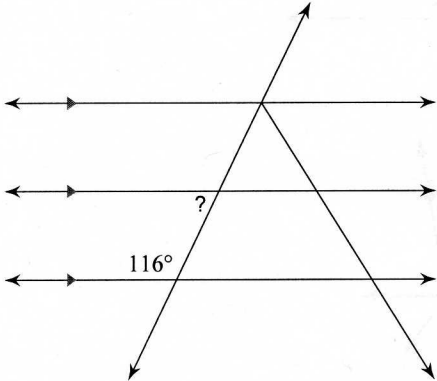

22)

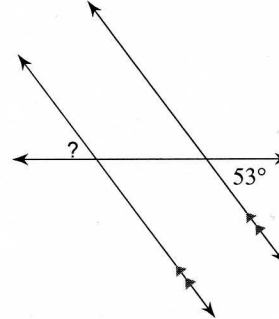

23)

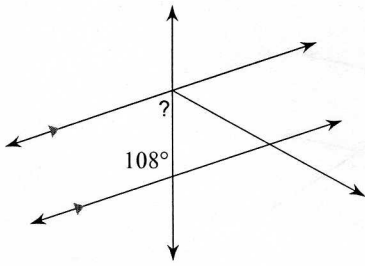

24)

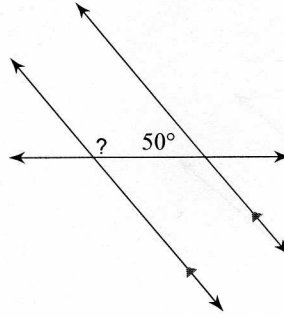

25)

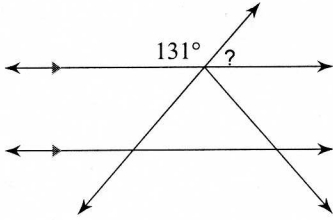

26)

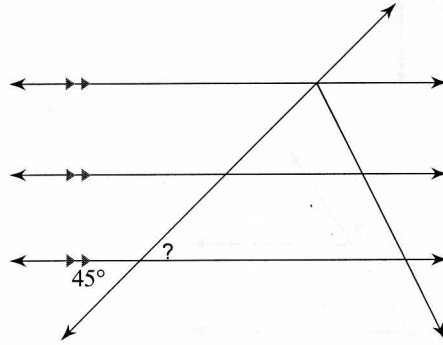

27)

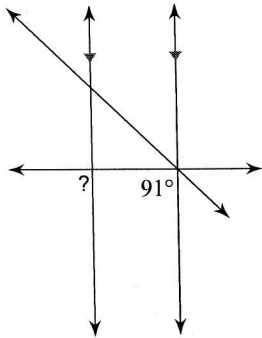

28)

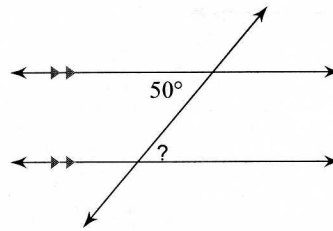

29)

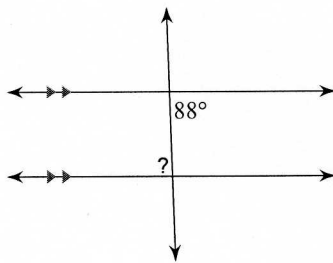

30)

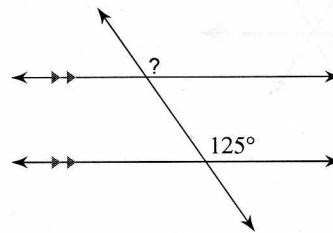

31)

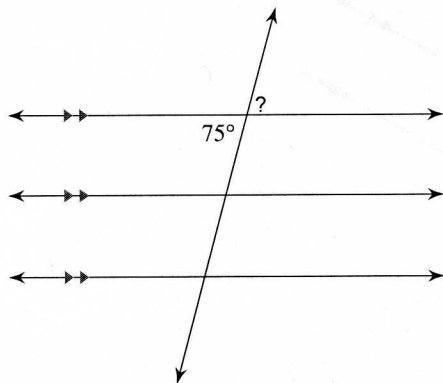

32)

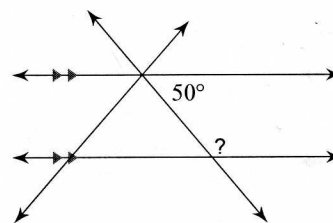

33)

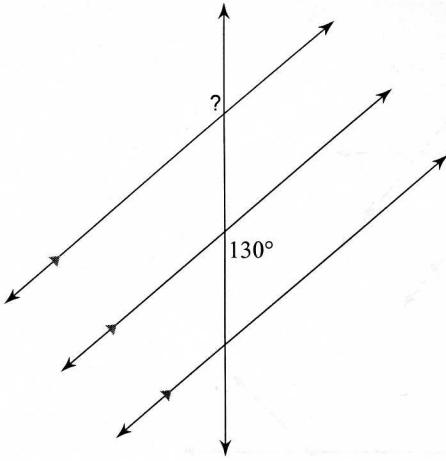

34)

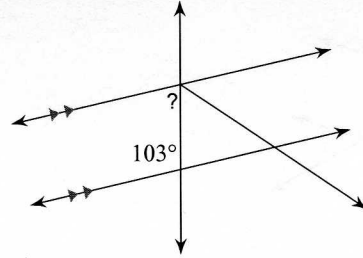

35)

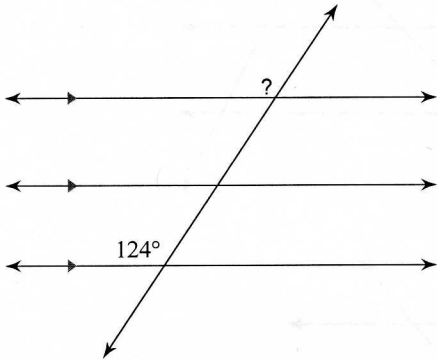

36)

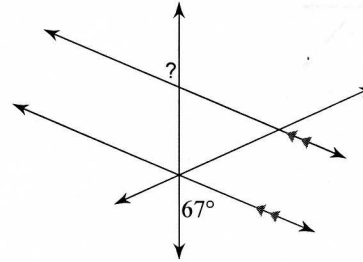

37)

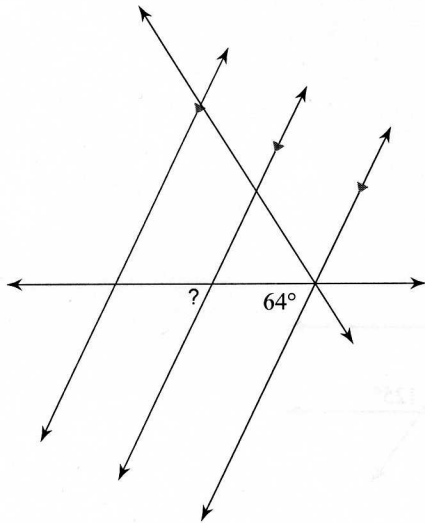

38)

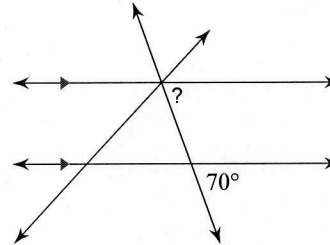

39)

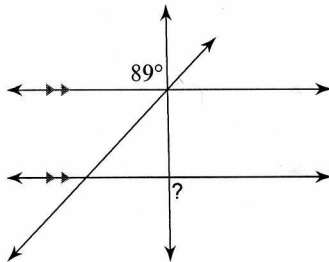

40)

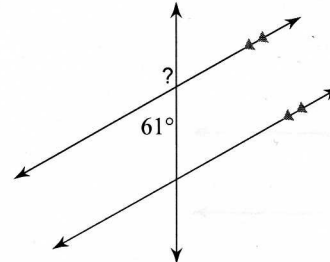

- Answers to 6-5 Transversals & Parallel Lines (ver2)_hw
- | | | | |
|----------|----------|----------|----------|
| 1) 109° | 2) 112° | 3) 50° | 4) 84° |
| 5) 65° | 6) 115° | 7) 50° | 8) 98° |
| 9) 126° | 10) 129° | 11) 133° | 12) 100° |
| 13) 117° | 14) 100° | 15) 86° | 16) 133° |
| 17) 67° | 18) 127° | 19) 56° | 20) 75° |
| 21) 64° | 22) 53° | 23) 72° | 24) 130° |
| 25) 49° | 26) 45° | 27) 91° | 28) 50° |
| 29) 88° | 30) 125° | 31) 75° | 32) 130° |
| 33) 130° | 34) 77° | 35) 124° | 36) 67° |
| 37) 64° | 38) 70° | 39) 89° | 40) 119° |